

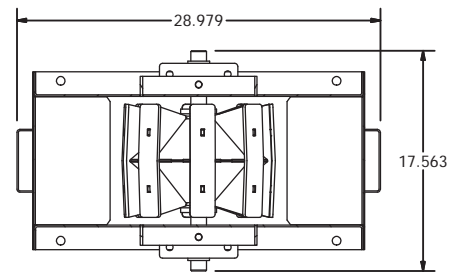

Bucket Elevator Spec Sheet

1200 series Chain Drive

OPTIONAL: INLET PANELS

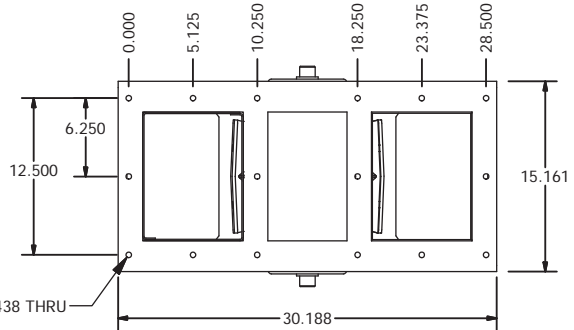
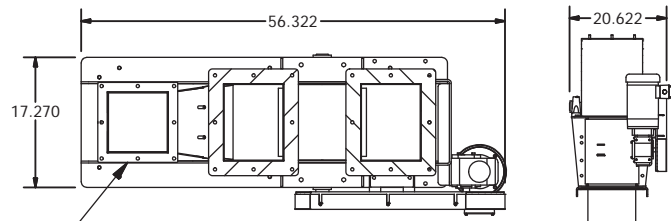
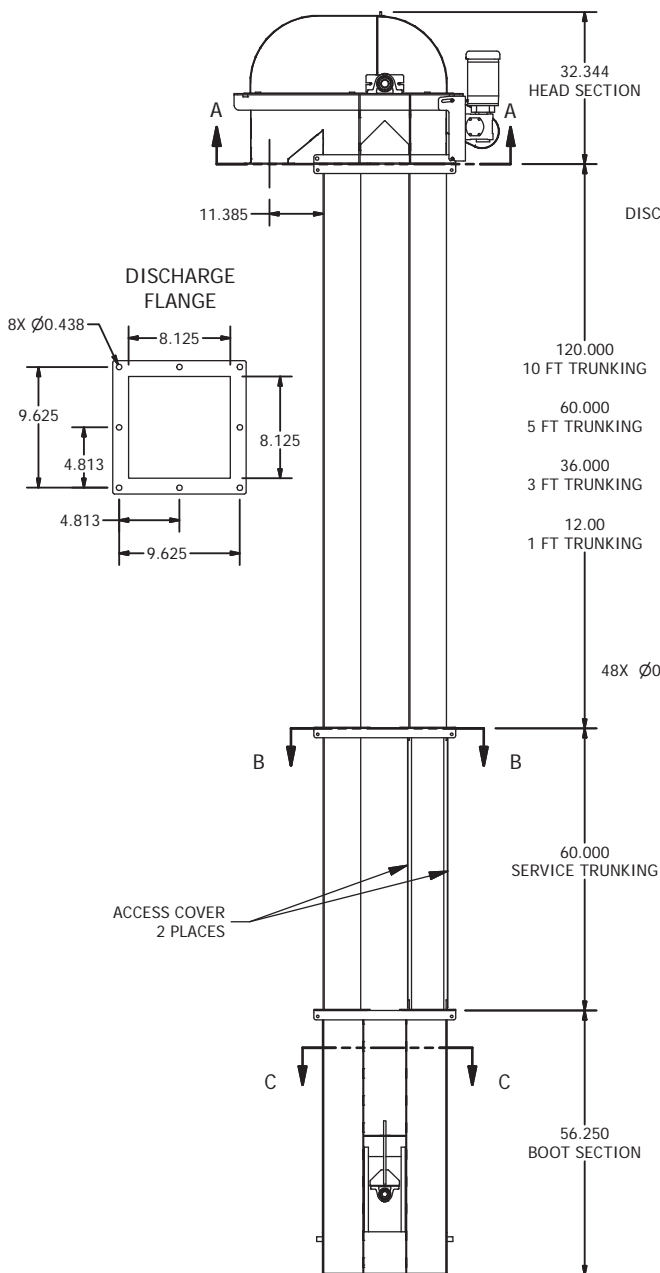
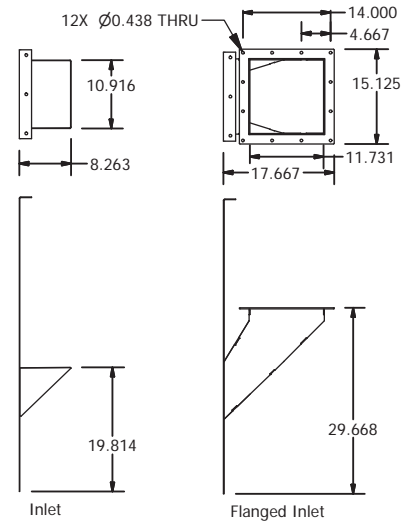

12" Drum x 9" Wide

